

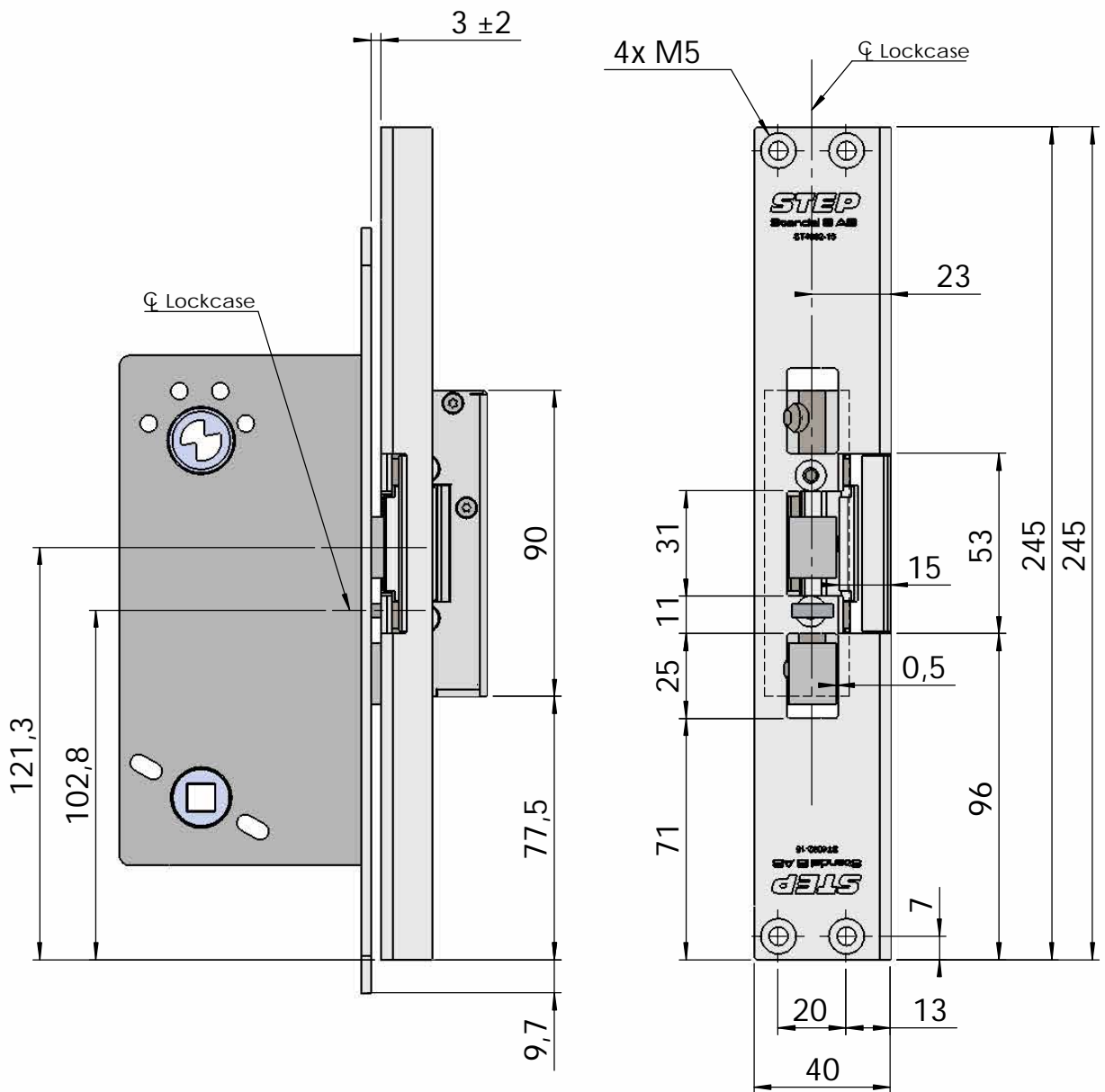

Montering för Modul



This document shall not be copied without owners written allowance and its content shall not be exposed for third part nor be used for unauthorized purpose.

Owner
Stendals EI AB

Title/Description
STEP 40 med vinklad stolpe plös 15mm
Montering för Modul

Drawing no.
ST4002-15

Scale
1:2

